

NKXR15-XL

Needle roller/axial cylindrical roller bearing

Schaeffler ID:
0507805300000

Needle roller/axial cylindrical roller bearings NKXR, axial component, single direction, to DIN 5429, without end cap, for oil lubrication

X-life

Technical information

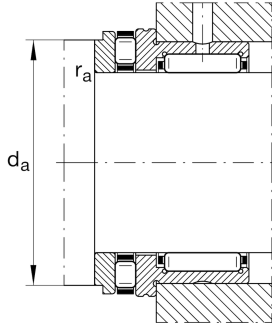
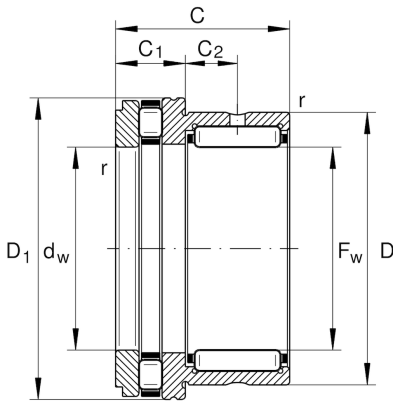

Main Dimensions & Performance Data

F_w	15 mm	Bore diameter
D	24 mm	Outside diameter
C	23 mm	Height
C_r	12,100 N	Basic dynamic load rating, radial
C_{0r}	12,700 N	Basic static load rating, radial
C_a	14,400 N	Basic dynamic load rating, axial
C_{0a}	28,500 N	Basic static load rating, axial
C_{ur}	2,360 N	Fatigue load limit, radial
C_{ua}	4,050 N	Fatigue load limit, axial
n_G	13,000 1/min	Limiting speed
n_{gr}	6,500 1/min	Reference speed
	41.38 g	Weight

Dimensions

$D_{1\max}$	28.1 mm	Maximum outside diameter flange
	IR12X15X16-XL	Suitable inner rings IR
$D_{2\max}$	28.1 mm	Maximum outside diameter flange
C_1	9 mm	Width of the axial bearing component
C_2	6.5 mm	Distance to lubrication hole
d_w	15 mm	Bore diameter of shaft washer
r_{\min}	0.3 mm	Minimum chamfer dimension

Mounting dimensions

d_a	23.7 mm	Mounting dimension shaft shoulder
$r_{a\max}$	0.3 mm	Maximum recess radius

Temperature range

T_{\min}	-30 °C	Operating temperature min.
T_{\max}	120 °C	Operating temperature max.